



 **Bodypoint**[®]

STRENGTHEN YOUR POSITION

Officially available through Invacare

Trusted Solutions, Passionate People



Positioning



It's personal.

Sometimes the right positioning means a person is able to compete as an Olympic athlete. Sometimes it means relief from pressure sores. Sometimes it enables an upright posture improving function that raises someone's self-esteem.

Whatever the reason, positioning has a huge influence on the quality of life for people using wheelchairs.

At Bodypoint®, while we work tirelessly to create extraordinary positioning products, our true mission is helping people achieve their full potential.

We are champions of positioning.

champions.

Table of Contents



4-5

PELVIC POSITIONING

Padded Hip Belts
Evoflex® Pelvic Stabilizer
T-Slot Fastener Kit



6-7

UPPER BODY POSITIONING

Stayflex™ Chest Supports
PivotFit™ Shoulder Harnesses
Trimline Shoulder Harness
Monoflex™ Chest Supports



8

LOWER BODY POSITIONING

Ankle Huggers® Support Straps
Calf Panels and Calf Straps



9

SIZING



Look for this symbol for products tested to the new postural support device wheelchair seating standards.



Learn more at
www.bodypoint.com/standards

Select a Bodypoint® Hip Belt

1 SELECT BELT TYPE



Two-Point Hip Belt

Padded, comfortable support for postural alignment. Simple-to-use and easy to clean.



Four-Point Hip Belt

Assures that the pelvis stays in an aligned, stable position. Extra points keep belt from moving up and riding into the abdomen.



Evoflex® Pelvic Stabilizer

Stiffened straps stay in place for easy buckling and won't get tangled in your wheels. Close fit provides stability and control.

2 SELECT BUCKLE



Push-Button Buckle

Low profile, smooth, snag-free corners. Removable cover for changing release hole size and easy cleaning. Standard Access Cover included. Reduced Access Cover and Security Cover sold separately.

OPTIONAL COVERS:



Reduced Access Cover

FS018D-1 1-1/2", Ø14mm button
For use with M46 belts.

FS019D-1 2", Ø14mm button
For use with L62 belts.



Security Cover

FS018C-1 1-1/2", Ø6mm button
For use with M46 belts.

FS019C-1 2", Ø6mm button
For use with L62 belts.



Side-Release

Lightweight, secure snap action.



Extra Small Metal Push-Button

Strong, secure, child-sized buckle.



Rehab Latch™ Buckle

Lightweight, strong, low profile, easy to operate with limited hand function. Note: Evoflex® Pelvic Stabilizer only.

3 SELECT PULL TYPE



Center-Pull Hip Belt

For clients with low muscle tone or weakness.



Dual-Pull Hip Belt

For clients requiring greater adjustment to accommodate clothing and weight changes.



Rear-Pull Hip Belt

For clients with high tone. Counters pelvic rotation by allowing the caregiver to position one side of the pelvis, lock it in place and then position on the other side.

4 SELECT A SIZE

See page 9 for sizing and measurement details.

5 SELECT A MOUNTING OPTION



-B2 **Cinch-Mount™**
Time saving, precise, easy adjustment

OR



-B1 **Flat-Mount™**
Versatile, lowest profile

BARRY

Barry's enthusiasm for life and adventure is contagious. An intrepid explorer, his extreme sports exploits give him a unique way to test the limits of his equipment. Barry discovered more stability and mobility using the Evoflex® Pelvic Stabilizer.



6 SELECT PART NUMBER



		TWO-POINT HIP BELTS		FOUR-POINT HIP BELTS	EVOFLEX PELVIC STABILIZER		
		Size	Push-Button	Side-Release	Push-Button	Push-Button	Rehab Latch
CENTER-PULL	S38		HB235-S38-B2		HB435-S38-B2	EB235XS	
	M46		HB205-M46-B1 HB205-M46-B2		HB405-M46-B1 HB405-M46-B2		EB225M
	L62		HB205-L62-B1 HB205-L62-B2		HB405-L62-B1 HB405-L62-B2		EB225L
DUAL-PULL	S38			HB216-S38-B2			
	M46			HB216-M46-B2			
	L62			HB216-L62-B2			
REAR-PULL	S38			HB219-S38-B2			
	M46			HB219-M46-B2			
	L62						

7 OPTIONAL HARDWARE

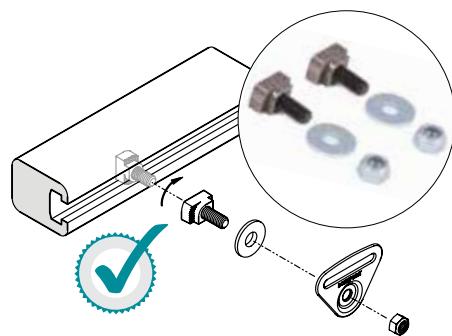

T-Slot Fastener Kit

Direct mount Bodypoint hip belts to Invacare® Modulite seating systems with the 10mm (1/4") T-slot Fastener Kit. Made out of alloy steel, this easy-to-use kit works with Cinch-Mount™ and Flat-Mount™ End fittings. Used with the Evoflex® Pelvic Stabilizer, it offers a low profile mounting solution. Sold as a pair. **HKA10-1**

Invacare® Modulite™



JORDAN

Using the PivotFit™ Shoulder Harness, Jordan gained stability and head control. This enables him to successfully operate a head array mouse system for computer use in school and for fun.

Choose the right



Stayflex™ Chest Support

Provides firm trunk control without sacrificing comfortable shoulder movement.

- Patented "dual zone" elastic construction virtually eliminates upward shifting at the neckline
- Optimal balance between stretch and resistance make it the best choice for long-term stability and performance



Monoflex™ Chest Support

Provides strong, comfortable abdominal/chest support.

- Engineered dynamic padding controls stretch and stabilizes even strong spastic tone
- Double-tapered shape distributes pressure across the mid-section

support for comfort, fit and function

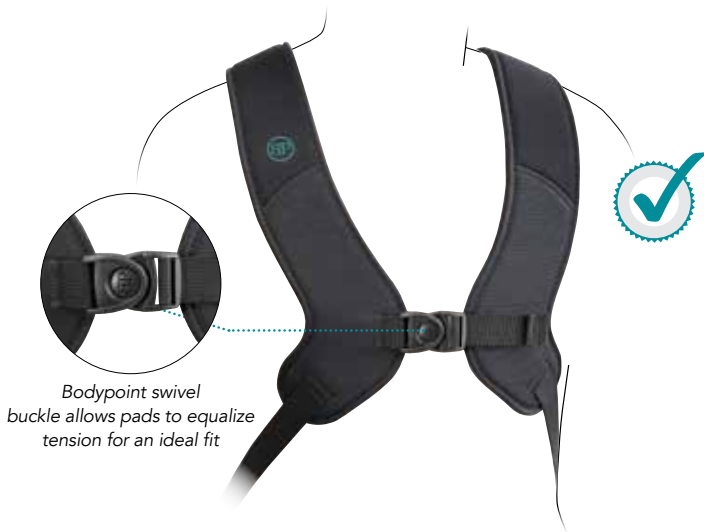

PivotFit™ Shoulder Harness

Provides shoulder positioning to help individuals sit upright for easier breathing, better head control and greater stability.

- Body-contouring shape provides optimal support and a comfortable fit
- High-strength swivel buckle allows for precise pad placement for an individualised fit
- Available in a non-stretch or a dynamic style



The standard non-stretch model for more aggressive control.



The dynamic model allows controlled movement to reduce spastic tone.

Trimline Shoulder Harness

Gives users support while allowing the most freedom across the chest. Provides the most aggressive approach to shoulder retraction.

- Independent pads and versatile configurations: backpack style or crossed at the sternum
- Tapered pads and a buckle-free front allow a comfortable and modest fit for women



In a backpack configuration, the Trimline gives the greatest amount of shoulder control.



All styles feature front-pull attachment.
This provides the maximum stability while allowing adjustment standing either behind or in front of the person.

Size	STAYFLEX		PIVOTFIT		TRIMLINE	MONOFLEX
	Standard Without Zipper	Narrow With Zipper	Standard	Dynamic		
XXS			SH250XXS-B2	SH270XXS-B2		
XS	SH311XS-B2		SH250XS-B2	SH270XS-B2		SH120XS-B3
S	SH311S-B2		SH250S-B2	SH270S-B2	SH230S-B2	SH120S-B3
M		SH330M-B2	SH250M-B2	SH270M-B2	SH230M-B2	SH120M-B3
L		SH330L-B2	SH250L-B2	SH270L-B2	SH230L-B2	SH120L-B3
XL		SH330XL-B2	SH250XL-B2	SH270XL-B2		SH120XL-B3

As always, a pelvic support should be worn with any anterior support product.

NOEL

Noel likes his equipment to be light and comfortable. The push button buckle design is sleek and low-profile with its rounded edges that improve comfort and prevent snagging on clothing.



Side-release Ankle Huggers® Support Straps

Sold in pairs.

Adjustment strap retains its precise position with every use, and side-release buckle ensures strong closure even with extensive use.



Aeromesh® Calf Panel

Features our exclusive Aeromesh® material. Aeromesh® fabric is bonded to a durable stiffener to allow air flow while maintaining shape.



Aeromesh® Padded Calf Straps

Calf Straps provide comfortable support, keeping feet safely on the footplates. Retains its shape for the best pressure distribution and durability.



Size	ANKLE HUGGERS	CALF PANEL	CALF STRAPS
XS	FT220XS		
S	FT220S	SP103S	SP102S
M	FT220M	SP103M	SP102M
L	FT220L	SP103L	SP102L
XL	FT220XL		



Hip Belts and Evoflex® Pelvic Stabilizer

1. Determine the most effective position for the belt.
2. Using a flexible tape measure, measure the distance over the body. This corresponds to the belt's padded length (measurement B).
3. Select the belt size.

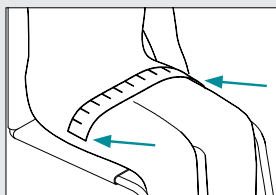

Belt Size	Range
S38	30-38cm (12-15")
M46	39-46cm (15-1/2 - 18")
L62	47-62cm (18-1/2 - 24-1/2")



Watch videos to learn more at www.youtube.com/user/BodypointInc

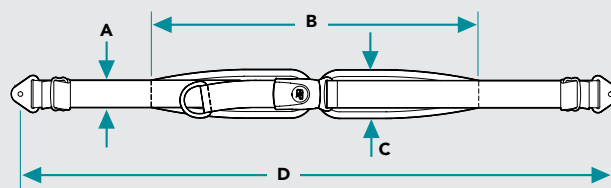

Product Measurements for Hip Belts

Size	A	B	C	D
S38	2.5cm (1")	38cm (15")	5cm (2")	117cm (46")
M46	4cm (1-1/2")	46cm (18")	6cm (2-1/4")	142cm (56")
L62	5cm (2")	62cm (24-1/2")	7cm (2-3/4")	155cm (61")

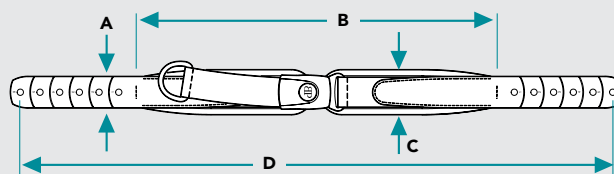

Product Measurements for Evoflex® Pelvic Stabilizers

Size	A	B	C	D
S38	2.5cm (1")	38cm (15")	5cm (2")	63cm (24-3/4")
M46	4cm (1-1/2")	46cm (18")	6cm (2-1/4")	76cm (29-3/4")
L62	5cm (2")	62cm (24-1/2")	7cm (2-3/4")	96cm (37-3/4")

Stayflex™, PivotFit™ and Trimline Shoulder Harnesses

Measure shoulder width. If the shoulder width falls between two sizes, consider other factors such as growth, weight changes, and clothing.

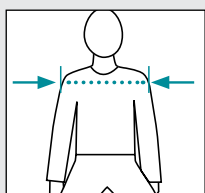

Size	Shoulder Width
XS	24-28cm (9-1/2-11")
S	28-33cm (11-13")
M	33-41cm (13-16")
L	41-48cm (16-19")
XL	48-56cm (19-22")

Monoflex™

Measure the person's trunk around the front and sides at the height at which the Monoflex™ will be worn. Refer to the fit range chart.

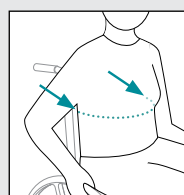

Size	Min/Max Fit Range
XS	36-45cm (14-17-1/2")
S	46-55cm (18-21-1/2")
M	56-65cm (22-25-1/2")
L	66-75cm (26-29-1/2")
XL	76-85cm (30-33-1/2")

Aeromesh® Calf Supports

For proper fit, measure chair width.

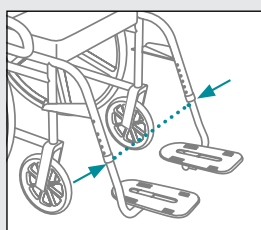

S	31cm-38cm (12-15")
M	38cm-48cm (15-19")
L	48cm-56cm (19-22")

Ankle Hugger® Support Straps

Measure circumference above ankle.

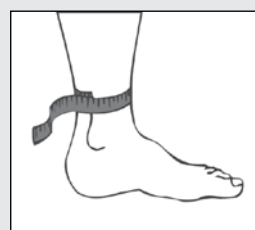

XS	14cm-17cm (5-1/2-7")
S	17cm-20cm (6-1/2-8")
M	19cm-23cm (7-1/2-9")
L	22cm-29cm (8-1/2-11-1/2")
XL	28cm-33cm (11-13")

	Stock Code	Description	
Hip Belts			
HB205 series			
	HB205-M46-B1	Hip Belt, Ctr-Pull, PB	M x 46cm Pads, F-Mt
	HB205-M46-B2	Hip Belt, Ctr-Pull, PB	M x 46cm Pads, C-Mt
	HB205-L62-B1	Hip Belt, Ctr-Pull, PB	L x 62cm Pads, F-Mt
	HB205-L62-B2	Hip Belt, Ctr-Pull, PB	L x 62cm Pads, C-Mt
HB405 series			
	HB405-M46-B1	Hip Belt, 4-pt, Ctr-Pull, PB	M x 46cm Pads, F-Mt
	HB405-M46-B2	Hip Belt, 4-pt, Ctr-Pull, PB	M x 46cm Pads, C-Mt
	HB405-L62-B1	Hip Belt, 4-pt, Ctr-Pull, PB	L x 62cm Pads, F-Mt
	HB405-L62-B2	Hip Belt, 4-pt, Ctr-Pull, PB	L x 62cm Pads, C-Mt
HB216			
	HB216-S38-B2	Hip Belt, Dual-Pull, SR	S x 38cm Pads, C-Mt
	HB216-M46-B2	Hip Belt, Dual-Pull, SR	M x 46cm Pads, C-Mt
	HB216-L62-B2	Hip Belt, Dual-Pull, SR	L x 62cm Pads, C-Mt
HB219			
	HB219-S38-B2	Hip Belt, Rear-Pull, SR	S x 38cm Pads, C-Mt
	HB219-M46-B2	Hip Belt, Rear-Pull, SR	M x 46cm Pads, C-Mt
HB235 series			
	HB235-S38-B2	Hip Belt, Ctr-Pull, PB	S x 38cm Pads, C-Mt
HB435 series			
	HB435-S38-B2	Hip Belt, 4-pt, Ctr-Pull, PB	S x 38cm Pads, C-Mt
	EB235XS	Evoflex Pelvic Stabilizer	X-Small, PB
	EB225M	Evoflex Pelvic Stabilizer	Medium, Latch
	EB225L	Evoflex Pelvic Stabilizer	Large, Latch
	FS018D-1	Push Button Reduced Access Cover	1-1/2", Ø14mm Hole, Gr
	FS019D-1	Push Button Reduced Access Cover	2", Ø14mm Hole, Gr
	FS018C-1	Push Button Security Cover	1-1/2", Ø6mm Hole, Gray
	FS019C-1	Push Button Security Cover	2", Ø6mm Hole, Gray
	FS029C-1	Push Button Security Cover	1" PB Buckle



Push buckle



Push buckle



Side-release buckle



Side-release buckle



XS Push buckle



XS Push buckle



M/L Rehab Latch buckle



Shoulder Harnesses/chest belts

Monoflex			
	SH120XS-B3	Monoflex, Front-Pull	X-Small, Grommet Stp
	SH120S-B3	Monoflex, Front-Pull	Small, Grommet Strap
	SH120M-B3	Monoflex, Front-Pull	Medium, Grommet Stp
	SH120L-B3	Monoflex, Front-Pull	Large, Grommet Strap
	SH120XL-B3	Monoflex, Front-Pull	X-Large, Grommet Stp





	Stock Code	Description	
PivotFit			
	SH250S-B2	PivotFit Shoulder Harness	Small, Fr-Pull, C-Mt
	SH250M-B2	PivotFit Shoulder Harness	Medium, Fr-Pull, C-Mt
	SH250L-B2	PivotFit Shoulder Harness	Large, Front-Pull, C-Mt
	SH250XL-B2	PivotFit Shoulder Harness	X-Large, Fr-Pull C-Mt
	SH250XS-B2	PivotFit Shoulder Harness	X-Small, Fr-Pull, C-Mt
	SH250XXS-B2	PivotFit Shoulder Harness	XX-Small, w/CM096
PivotFit Dynamic Shldr Hrness			
	SH270L-B2	PivotFit Dynamic Shldr Hrness	Large, Front-Pull, C-Mt
	SH270M-B2	PivotFit Dynamic Shldr Hrness	Medium, Front-Pull C-Mt
	SH270S-B2	PivotFit Dynamic Shldr Hrness	Small, Front-Pull, C-Mt
	SH270XL-B2	PivotFit Dynamic Shldr Hrness	X-Large, Frnt-Pull C-Mt
	SH270XS-B2	PivotFit Dynamic Shldr Hrness	X-Small, Frnt-Pull C-Mt
	SH270XXS-B2	PivotFit Dynamic Shldr Hrness	XX-Small, Frnt-PLI C-Mt
Stayflex			
	SH311XS-B2	Stayflex, Std, Front-Pull	X-Small, w/o zip, C-Mt,
	SH311S-B2	Stayflex, Std, Front-Pull	Small, w/o zip, C-Mt
	SH330M-B2	Stayflex, Narrow, Front-Pull	Medium, w/zipper, C-Mt,
	SH330L-B2	Stayflex, Narrow, Front-Pull	Large, w/zipper, C-Mt
	SH330XL-B2	Stayflex, Narrow, Front-Pull	X-Large, w/zipper, C-Mt
Trimline			
	SH230S-B2	Shoulder Harness, Front-Pull	Small, Trimline, C-Mt
	SH230M-B2	Shoulder Harness, Front-Pull	Medium, Trimline, C-Mt
	SH230L-B2	Shoulder Harness, Front-Pull	Large, Trimline, C-Mt

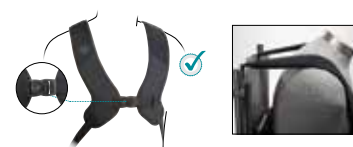
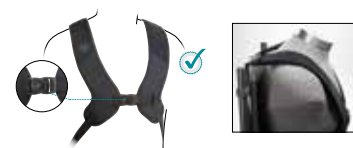

Ankle harnesses/calf support

Ankle hugger			
	FT220XS	Ankle Huggers, SR	X-Small, Pkg
	FT220S	Ankle Huggers, SR	Small, Pkg
	FT220M	Ankle Huggers, SR	Medium, w/Adj Mt, Pkg
	FT220L	Ankle Huggers, SR	Large, w/Adj Mt, Pkg
	FT220XL	Ankle Huggers, SR	X-Large, Pkg
Calf Strap			
	SP102S	Calf Strap, Aeromesh	Small, 32"
	SP102M	Calf Strap, Aeromesh	Medium, 36"
	SP102L	Calf Strap, Aeromesh	Large, 40"
Calf Panel			
	SP103S	Calf Panel, Aeromesh	Small, 32-1/2"
	SP103M	Calf Panel, Aeromesh	Medium, 35-1/2"
	SP103L	Calf Panel, Aeromesh	Large, 38-1/2"



Hardware

	HKA10-1	T-Slot Fastener Kit	M6x 14 for 10mm T-Slot, Pr
	FA814-14MM-1000	Nut w/ Stud, T-Slot, Qtr Turn	M6x 14, 10mm Slot, Pkg 1000

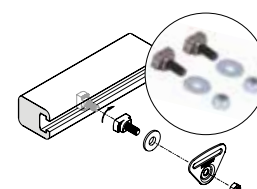

Invacare is an official UK distributor

Contacts – Seating & Positioning Team

Mark Babb

National Sales Manager
07977 980726
mbabb@invacare.com

Andy Boyes

North
07973 830336
aboyes@invacare.com

Adrian Turner

Central
07967 185839
aturner@invacare.com

Steve Nash

Wales & South West
07970 112992
snash@invacare.com

Jim Gaw

Scotland
07506 487859
jgaw@invacare.com

Darren Hume

London & South East
07903 298979
dhume@invacare.com

**Contact our Customer Services department on 01656 776222
or email ordersuk@invacare.com**

Invacare Limited
Pencoed Technology Park - Pencoed -
Bridgend CF35 5AQ - United Kingdom
Tel: +44 1 656 776 222
Fax: +44 1656 776 220
E-mail: uk@invacare.com
Sales Order E-mail:
ordersuk@invacare.com
www.invacare.co.uk

Invacare Ireland Ltd
Unit 5 - Seatown Business Campus
Seatown Road - SWORDS - County
Dublin - Ireland
Tel. +353 1 8107084
Fax +353 1 8107085
Email: Ireland@invacare.com
www.invacare.ie

© 2015 Invacare International Sàrl
All rights reserved.

Bodypoint - UK - 08/2015 - 1588127

Trusted Solutions, Passionate People

